



ENERGIA[™]
MOBILE

NEVER RUN OUT OF *ENERGY*
WHEN ON THE MOVE

PRODUCT GUIDE

MOBILIS[®]
CARE & CARRY

**FIND THE ENERGIA SOLUTION
THAT FITS YOUR NEEDS**

THE RANGE

ENERGIA MOBILE CHARGE • MOUNT • PROTECT • SECURE

p.4

Energia Mobile - Magnetic Pogo Pin Dongle (USB-C receiver)

ref : 020006



p.6



Energia Mobile + Charging Airvent Mount 65W

ref : 020007



p.8



Energia Mobile + Charging Suction Mount 65W

ref : 020008



p.10



Charging Tripod & Ring 65W - compatible Energia Mobile

ref : 020009



p.12



Magnetic Armband Compatible Energia Mobile

ref : 020012



p.14



Energia Dock - Charging station 5 slots 120W

ref EU : 020010
ref UK : 020011
ref US : 020021



p.16



Sled Smart Pin Adapter for Zebra RFD40

ref : 020019



p.18



Sled Bluetooth Adapter for Zebra RFD40

ref : 020020



p.20



**A UNIVERSAL FAST CHARGING
AND MOUNTING SOLUTION
FOR SMARTPHONES AND HHD.**

CHARGE

WITH **ENERGIA MOBILE** : MOVE THE USB-C PORT TO THE BACK OF YOUR SMARTPHONE.

Optimize the connectivity and charging of your device with the Magnetic POGO PIN Dongle (ref. 020006). Once connected to its mount, it ensures fast, stable, and lossless power delivery.

- ✦ **Ultra-fast charging up to 65W via USB-C 2.0**
- ✦ **High-speed data transfer up to 480 Mbps**
- ✦ **Quick charge up to 80% battery in under 30 minutes**

Thanks to its smart magnetic system, the dongle enables instant connection to all **ENERGIA MOBILE** ecosystem mounts, ensuring a smooth and seamless user experience.

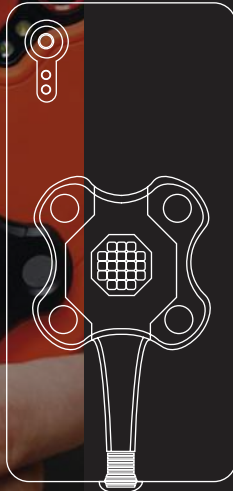

PROTECT

EXTEND THE LIFESPAN OF YOUR USB-C PORT.

Thanks to its magnetic connection system, the USB-C connector is effectively **protected from wear caused by repeated plugging and accidental disconnections.**

Engineered for performance, it withstands up to **100,000 usage cycles.**

Equipped with 4 strong magnets (each with a pulling force of 3.5 kg / 7G), it ensures a secure and reliable attachment to all **ENERGIA** ecosystem mounts.

- ✦ **Charging stations**
- ✦ **Vehicle mounts**
- ✦ **Portability solutions**

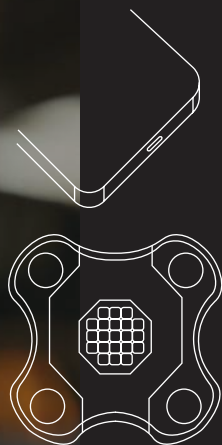

UNIVERSAL COMPATIBILITY WITH ALL SMARTPHONES EQUIPPED WITH A USB-C PORT.

The **ENERGIA MOBILE** magnetic POGO receiver is the essential component for relocating the USB-C connector.



SAMSUNG **iPhone** **Pixel** **Motorola** **ZEBRA**

It attaches directly to your phone or to a compatible **MOBILIS®** case.

MOUNT

A WIDE RANGE OF MOUNTS THANKS TO THE MAGNETIC SYSTEM INTEGRATED ON THE BACK OF THE SMARTPHONE.

Position your device in a single motion with an **intuitive magnetic mounting system** designed to adapt to any situation.

Whether in the car, at the office, or on the go, mount and charge your phone effortlessly. It stays secure, within reach, and ready to use at all times.

Take advantage of universal charging stations that can **power multiple devices simultaneously**, simplifying the management of your entire mobile fleet.

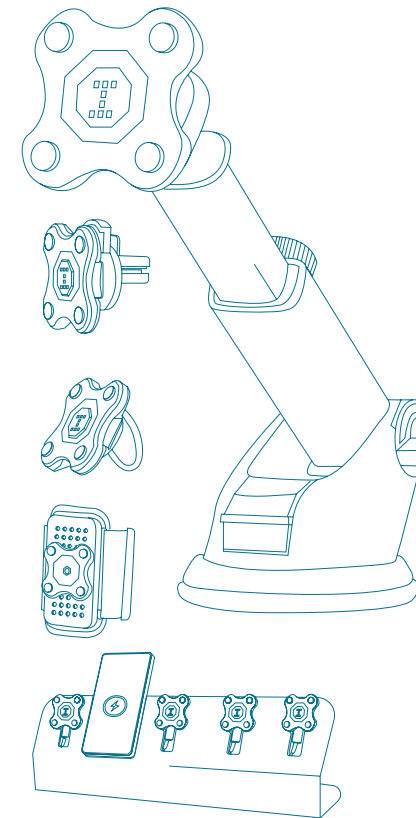

SECURE

A PROFESSIONAL SOLUTION FOR EVERY JOB.

- | | | | |
|---------------------|--|--------------|-------------|
| Transport Logistics | Retail | Food Service | Office |
| Industry Warehouse | Defense Security
Emergency Services | Healthcare | Home Office |

MAGNETIC DONGLE

POGO (USB-C receiver)

The magnetic receiver connector that allows your device to instantly connect to all mounts in the **ENERGIA MOBILE** ecosystem.

Ref : 020006 Magnetic Pogo Pin Dongle (USB-C receiver)



SMART MAGNETIC INTERFACE

It protects and redirects the original USB-C port to the back of the device, enabling charging and data transfer without manual plugging—for an instant and seamless connection.

EASY INSTALLATION

Quick, tool-free installation: easily attaches to the back of the device or its case using a 3M VHB adhesive, ensuring a durable hold with no need for readjustment.

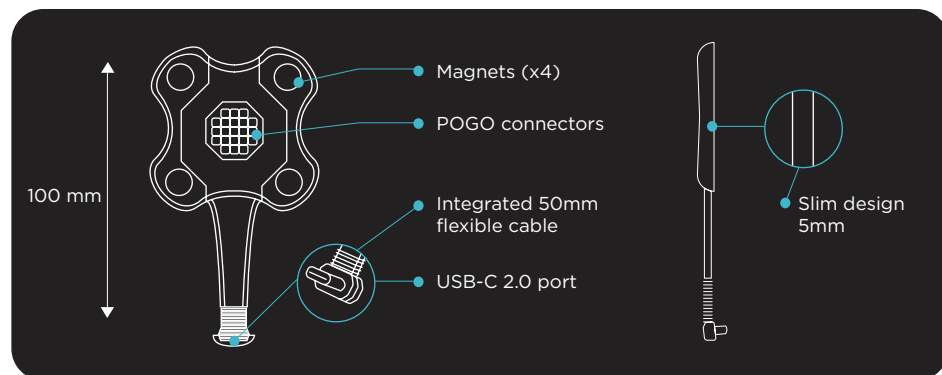

WITH THE MAGNETIC DONGLE, MAKE YOUR SMARTPHONE COMPATIBLE WITH A WIDE RANGE OF CHARGING AND MOUNTING SOLUTIONS.

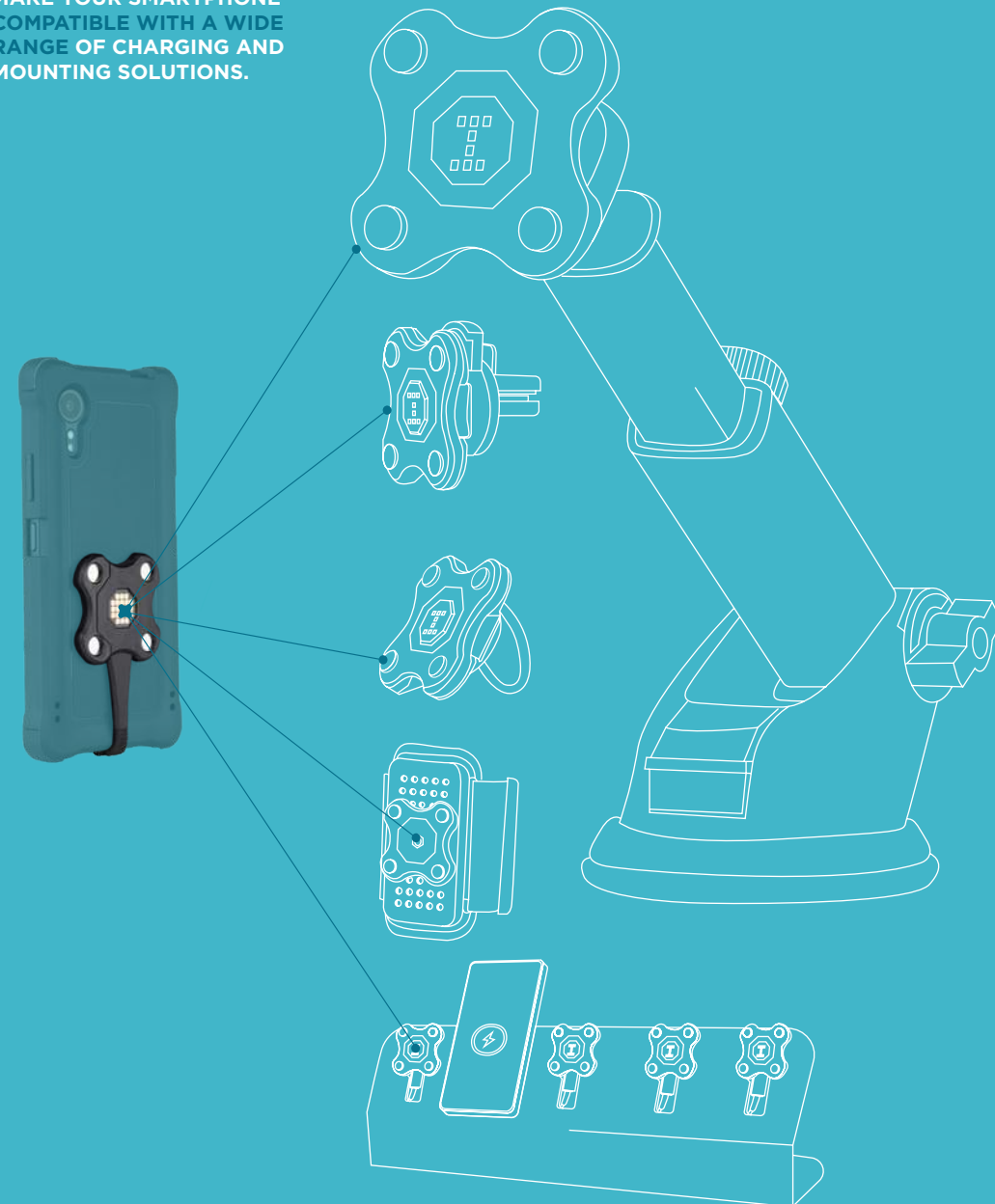

A UNIVERSAL SOLUTION

Compatible with all mobile devices equipped with a **centered USB-C port**, whether used with or without a protective case.

MADE IN FRANCE

CHARGING MOUNT

Air vent

Securely mount and charge your smartphone during your car journeys.

Ref : 020007 Energia Mobile + Charging Airvent Mount 65W



CONTINUOUS FAST CHARGING

This air vent mount lets you optimally charge your device during your trips. Once attached to your vehicle's air vent, it provides fast charging through its built-in USB-C port. Simply connect it to your car's USB-C port or lighter socket using a cable (not included) for continuous power.

*USB-C 2.0 - Data transfer up to 480 Mbps

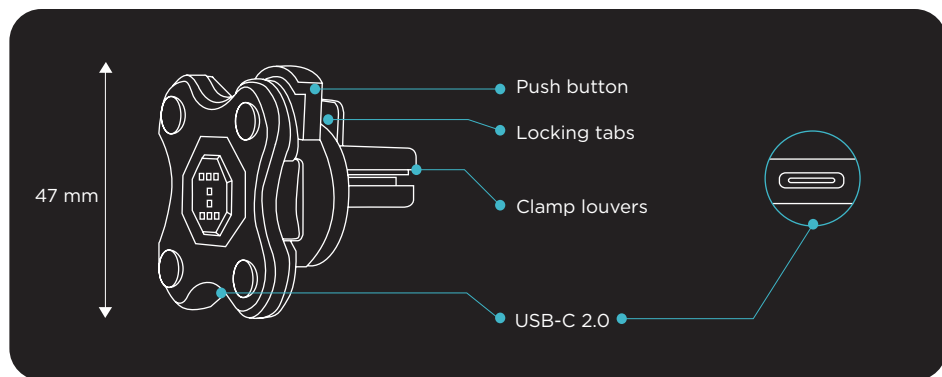

CLAMPING CLIP

A strong clip that securely attaches to one of your vehicle's air vents.



HOLDING SYSTEM

Stabilization mechanism that prevents the air vent from sagging while keeping the smartphone securely in place, ensuring optimal screen visibility.



USB-C 2.0



FAST CHARGING



MAGNETIC MOUNT



COMPACT AND LIGHTWEIGHT



PORTRAIT OR LANDSCAPE

MADE IN FRANCE

CHARGING SUCTION MOUNT

Windshield and dashboard

Designed for professionals: a practical suction mount to keep you connected.



Ref : 020008 Energia Mobile + Charging Suction Mount 65W

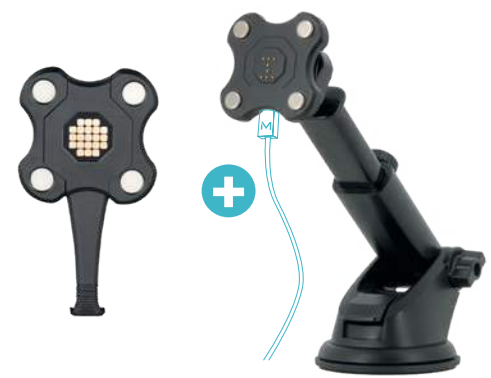

CONTINUOUS FAST CHARGING

Enjoy optimal charging during your trips with this suction mount for windshield or dashboard. Equipped with a USB-C port, it allows you to charge your device while keeping it securely in place. For power, simply connect a cable (not included) to your vehicle's 12V lighter socket or directly to the USB port.

* USB-C 2.0 - Data transfer up to 480 Mbps



ULTRA-STRONG MOUNTING

System combining suction cup and high-performance adhesive, ensuring a firm hold on the windshield or dashboard.



360° ROTATING BASE

Provides complete freedom of movement for a personalized viewing angle and maximum user comfort.



ADJUSTABLE TELESCOPIC ARM

Allows you to adjust the length from 115mm to 170 mm for optimal smartphone access, depending on your driving position.

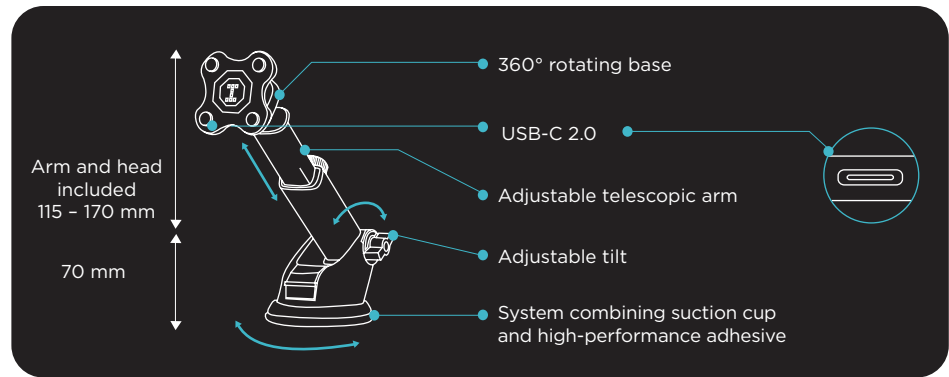

USB-C 2.0



FAST CHARGING



MAGNETIC MOUNT



STRONG AND DURABLE



PORTRAIT OR LANDSCAPE

MADE IN
FRANCE

TRIPOD & RING CHARGER

— ENERGIA MOBILE compatible

The essential mobile charger: convenient, secure, and always ready !

Ref : 020009 Charging Tripod & Ring 65W - compatible Energia Mobile



INNOVATIVE 3-IN-1 MOUNT

This mobile charger instantly attaches to the back of your smartphone or a compatible case using a magnetic POGO system.*1

The integrated POGO connectors ensure precise alignment, enabling seamless power transfer between your phone and a compatible Energia Mobile magnetic POGO charging accessory.*2 *3

*1 Adapter and cable not included.

*2 Ref: 020006 - Energia Mobile not included.

*3 USB-C 2.0 - Data transfer up to 480 Mbps

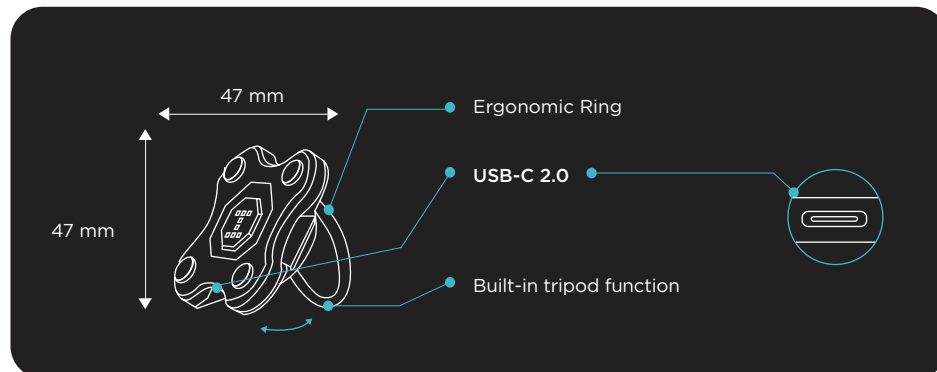

IDEAL FOR :



Travel



Office



Home Office

COMPACT AND DISCREET DESIGN

Lightweight, the Charging Tripod & Ring folds completely when not in use. It easily fits into a pocket or bag.

VERSATILE USE FOR ALL-TERRAIN CHARGING

Made from wear-resistant materials, this mount **combines durability and practicality** to suit all work environments.

ERGONOMIC REMOVABLE RING

Its holding ring provides a secure and comfortable grip. Perfect for **preventing accidental drops**, it also makes one-handed smartphone use easier and enhances stability when taking photos or videos.

BUILT-IN TRIPOD FUNCTION

With the tripod mode, position your smartphone in landscape orientation, ideal for watching videos or making video calls.

USB-C
2.0FAST
CHARGINGMAGNETIC
MOUNTSTRONG
AND DURABLE

ARMBAND MOUNT

ENERGIA MOBILE compatible

Free your hands – Boost your efficiency

MADE IN FRANCE

Réf : 020012 Magnetic Armband
- Compatible Energia Mobile



THE PERFECT SOLUTION FOR THE FIELD

The magnetic armband is specifically designed for professional environments that require **mobility and responsiveness**.

It securely holds a smartphone or data terminal on the forearm, providing quick access to the device while **freeing the operator's hands**.

This solution is especially suited for **logistics, maintenance, and field operations**.

A DAILY TIME SAVER

This discreet yet highly effective accessory transforms your smartphone into **an always-accessible tool**, without hindering movement or slowing down operations.

Ref: 020006 - Energia Mobile not included.

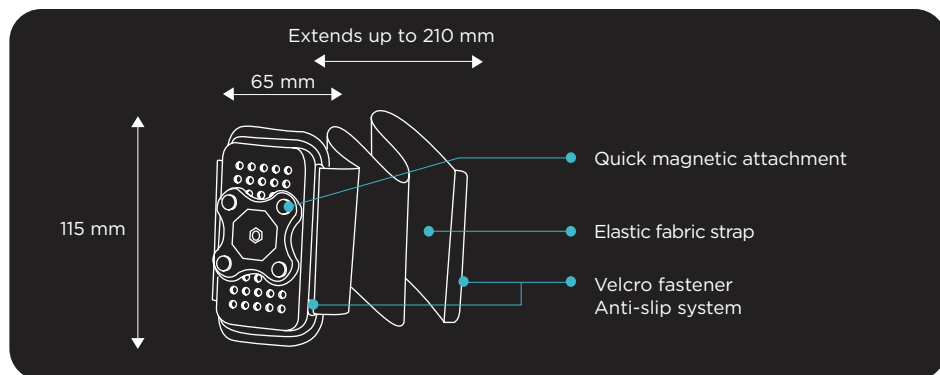

FAST AND SECURE MAGNETIC MOUNTING

Thanks to its powerful magnetic system (4 magnets with a 3.5 kg / 7G pull force each), **the smartphone attaches and detaches in seconds**. No more unreachable pockets or unstable mounts: your phone stays securely in sight and firmly held at all times.

A WORK TOOL ON YOUR WRIST

Whether following a GPS route, consulting a work order, receiving instructions, or scanning a QR code, everything becomes easier and more seamless. The armband lets you **stay connected without interrupting your main task**.

LONG-LASTING COMFORT

The technical fabric strap, adjustable with Velcro, **fits all body types** for maximum comfort.

UNIVERSAL COMPATIBILITY

When paired with the **Magnetic POGO PIN Dongle** (ref. 020006 - not included), the mount is compatible with all terminal models.



MAGNETIC MOUNT



STRONG AND DURABLE



PORTRAIT OR LANDSCAPE

MADE IN FRANCE

CHARGING STATION

5 positions – EU plug / UK plug / US plug

Charge all your smartphones simultaneously!

-  Ref : 020010 Energia Dock – Charging station 5 slots 120W - EU plug
-  Ref : 020011 Energia Dock – Charging station 5 slots 120W - UK plug
-  Ref : 020021 Energia Dock – Charging station 5 slots 120W - US plug



UNIVERSAL COMPATIBILITY

Compatible with all devices equipped with a centered USB-C port.

OPTIMIZED ERGONOMICS

One-step intuitive attachment and compact design for minimal bulk.

SPEED & POWER

Power Delivery technology and 120W GaN power supply with 6 USB-C ports, Quick Charge compatible for efficient charging.*1 Intelligent Power Allocation (IPA)*2.

*1 Ref: 020006 – Energia Mobile not included.

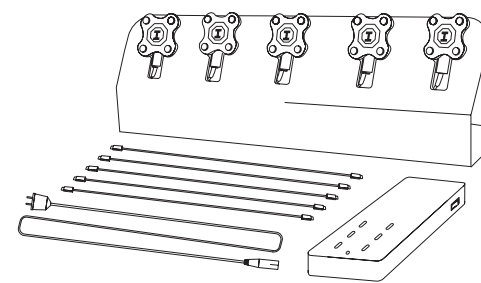
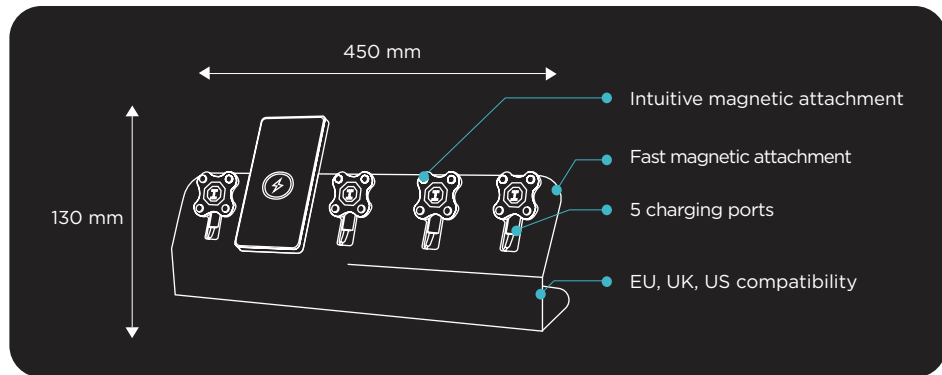

INCLUDED ACCESSORIES

Comes with five 30 cm USB-C cables (65W max*3) for **immediate, clutter-free connectivity.**

*3 65W Max charging – USB-C 2.0 / data transfer (480Mbps)

INTERNATIONAL COMPATIBILITY





Equipped with detachable power cords, including three versions compatible with EU, UK, and US plugs.

ROBUSTNESS AND DURABILITY

Durable PVC construction **designed for heavy use.** The POGO receivers are removable to facilitate maintenance (after-sales service).

*2 *Intelligent Power Allocation (IPA) is a technology used in multi-port USB chargers to optimize power distribution based on connected devices.*

Here's how it works :

-  *Device detection: The charger analyzes each connected device (smartphone, tablet, mobile terminal, etc.) to identify its power requirements.*
-  *Dynamic power allocation: It adjusts the power delivered to each port according to the specific needs of each device.*
-  *Overload prevention: When multiple devices are connected simultaneously, the charger ensures it does not exceed its total available power, preventing overheating or uneven power distribution.*
-  *Charging speed optimization: It allocates more power to devices requiring fast charging and reduces power to those nearly fully charged.*



USB-C 2.0



FAST CHARGING



MAGNETIC MOUNT



STRONG AND DURABLE

SLED SMART PIN eConnex™ ADAPTER

For Zebra RFD40

This premium solution combining an adaptive plate and an ENERGIA MOBILE dongle allows a smartphone to be magnetically connected to a Zebra RFD40 UHF RFID reader for simple, fast, and wireless use. Thanks to its Pogo Pin connection system compatible with eConnex™, it ensures smooth communication, perfectly suited to mobile environments or applications requiring high freedom of movement (inventory, stock management, logistics, etc.).

MADE IN FRANCE

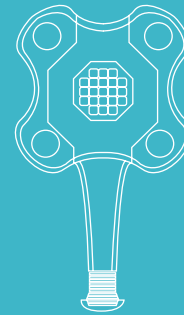

SMART MAGNETIC INTERFACE

It protects and redirects the original USB-C port to the back of the device, enabling charging and data transfer without manual plugging for an instant and seamless connection.



Ref : 020019 Energia Mobile - Zebra RFD40 Sled eConnex™ Adapter



ADAPTIVE SLED

The sled attaches to the RFD40 and features a dedicated slot designed to accommodate the ENERGIA MOBILE Pogo Pin dongle, secured by its four powerful magnets.

DATA TRANSMISSION

Our adapter converts data to enable smart communication between your smartphone's USB interface and the Zebra RFD40's eConnex™ interface.

UNIVERSAL COMPATIBILITY WITH ALL DEVICES EQUIPPED WITH A CENTRAL USB-C PORT

The ENERGIA MOBILE Pogo Pin dongle receiver allows the USB-C connector to be offset. It can be positioned directly on your device or on a compatible MOBILIS® case.

UNIVERSAL COMPATIBILITY THANKS TO THE ENERGIA MOBILE MAGNETIC POGO PIN RECEIVER

Réf. 020006 INCLUDED WITH THE REFERENCE.



SAMSUNG iPhone G Pixel M motorola ZEBRA



Compatible with smartphones equipped with a centered USB-C port, whether used with or without a protective case.

EASY INSTALLATION

Quick, tool-free installation: the mount attaches easily to the back of the device or its case using 3M VHB adhesive, ensuring long-lasting hold with no need for readjustment.

EASY ASSEMBLY

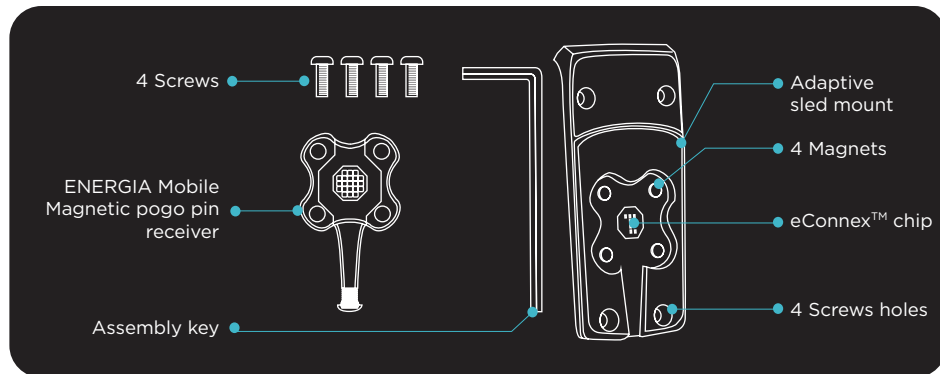

SLED BLUETOOTH ADAPTER

For Zebra RFD40

The ENERGIA MOBILE adaptive sled provides a quick and ergonomic way to attach (and detach) the smartphone to the Zebra RFD40 reader. It securely holds the device magnetically while ensuring smooth and reliable communication — ideal for mobile environments or applications that require great freedom of movement (inventory, stock management, logistics, etc.).

Réf : 020020 Energia Mobile - Zebra RFD40 Sled Bluetooth Adapter



MAGNETIC MOUNTING SLED

The sled attaches directly to the RFD40 reader. It features a slot designed to hold a magnetic dongle using its 4 strong magnets.

UNIVERSAL COMPATIBILITY WITH ALL MOBILE DEVICES

Thanks to the magnetic dongle, your device can be positioned on the mounting plate. The magnetic dongle can be attached directly to your device or to a compatible MOBILIS® protective case.

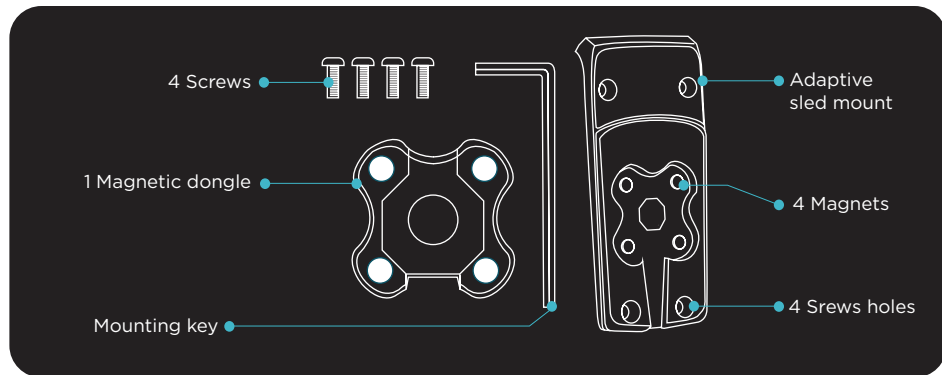

UNIVERSAL COMPATIBILITY WITH THE MAGNETIC DONGLE

Compatible with smartphones whether used with or without a protective case.



MAGNETIC INTERFACE

The dongle allows quick and secure attachment of the mobile device to the RFD40 by magnetically connecting to the female slot located in the adapter mount.

EASY INSTALLATION

Quick, tool-free installation: the mount easily attaches to the back of the device or its case using 3M VHB adhesive, ensuring long-lasting hold without the need for readjustment.

EASY ASSEMBLY



BLUETOOTH CONNECTION

MAGNETIC MOUNT

STRONG AND DURABLE

DOCKING COMPATIBILITY

FIND THE ENERGIA SOLUTION THAT FITS YOUR NEEDS

Discover the ENERGIA MOBILE range, designed to optimize your device's performance, whatever your usage or environment, all day long.



Magnetic POGO Pin Dongle
(USB-C receiver)

ref : 020006



p.6



Magnetic POGO Pin Dongle
+ Charging Airvent Mount 65W

ref : 020007



p.8



Magnetic POGO Pin Dongle
+ Charging Suction Mount 65W

ref : 020008

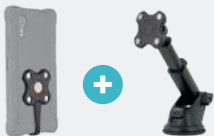

p.10



Charging Tripod & Ring 65W
Compatible Energia Mobile

ref : 020009



p.12

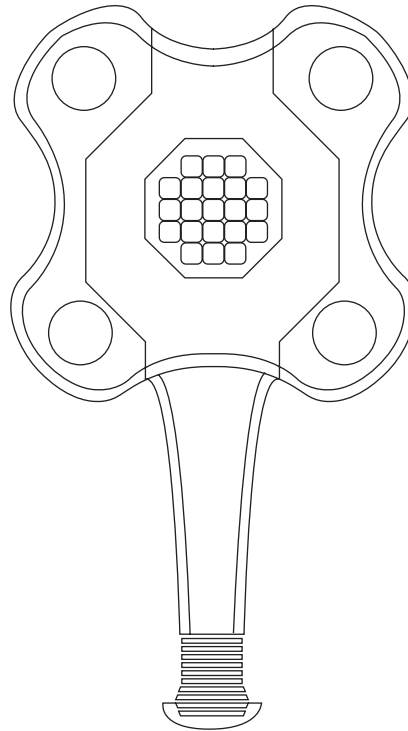

Magnetic Armband
Compatible Energia Mobile
ref : 020012

p.14



Energia Dock - Charging
station 5 slots 120W
ref EU : 020010
ref UK : 020011
ref US : 020021

p.16



Sled eConnex™ Adapter
for Zebra RFD40
ref : 020019

p.18



Sled Bluetooth Adapter
for Zebra RFD40
ref : 020020



AN EXPERT *ALWAYS* *BY YOUR SIDE*

USA / CANADA / LATAM

Linda MEBROUKI
International Channel
DC Manager
Tel. +33 682 005 064
lmebrouki@mobiliscase.com

UNITED KINGDOM

Virginie BIGOT
Head of UK Channel
Tel. +44 7399 289 575
vbigot@mobiliscase.com

IBERIA

Jara GONZALEZ
DC Channel Developer
Tel. +34 650 639 691
jgonzalez@mobiliscase.com

DACH

Aleksandra ZORGIEL
DC Channel Manager
Tel. +49 1755 850 787
azorgiel@mobiliscase.com

PORTUGAL

Kelly REZIGUE
Business Developer
Tel. +33 750 655 749
krezigue@mobiliscase.com

EASTERN EUROPE

MIDDLE EAST NORDICS NORTH AFRICA

Quentin CIMMINO
DC Channel Developer
Tel. +33 688 927 618
qcimmino@mobiliscase.com

ITALY

Roberto DI DIEGO
Distribution Manager
Tel. +39 347 104 8942
rdiego@mobiliscase.com

BENELUX

Axel LEBRUN
DC Channel Manager
Tel. +33 146 439 208
alebrun@mobiliscase.com

DACH

Volker HARTLEIF
IT Channel Manager
Tel. +49 160 9633 6400
vhartleif@mobiliscase.com

MIKAËL TANGUY - Global Sales Director
Distribution, Partnership & Alliance

ENERGIATM
 **MOBILE**

FOLLOW US!



@MOBILIS DataCapture



@MOBILIS

